

## P8 HEADER

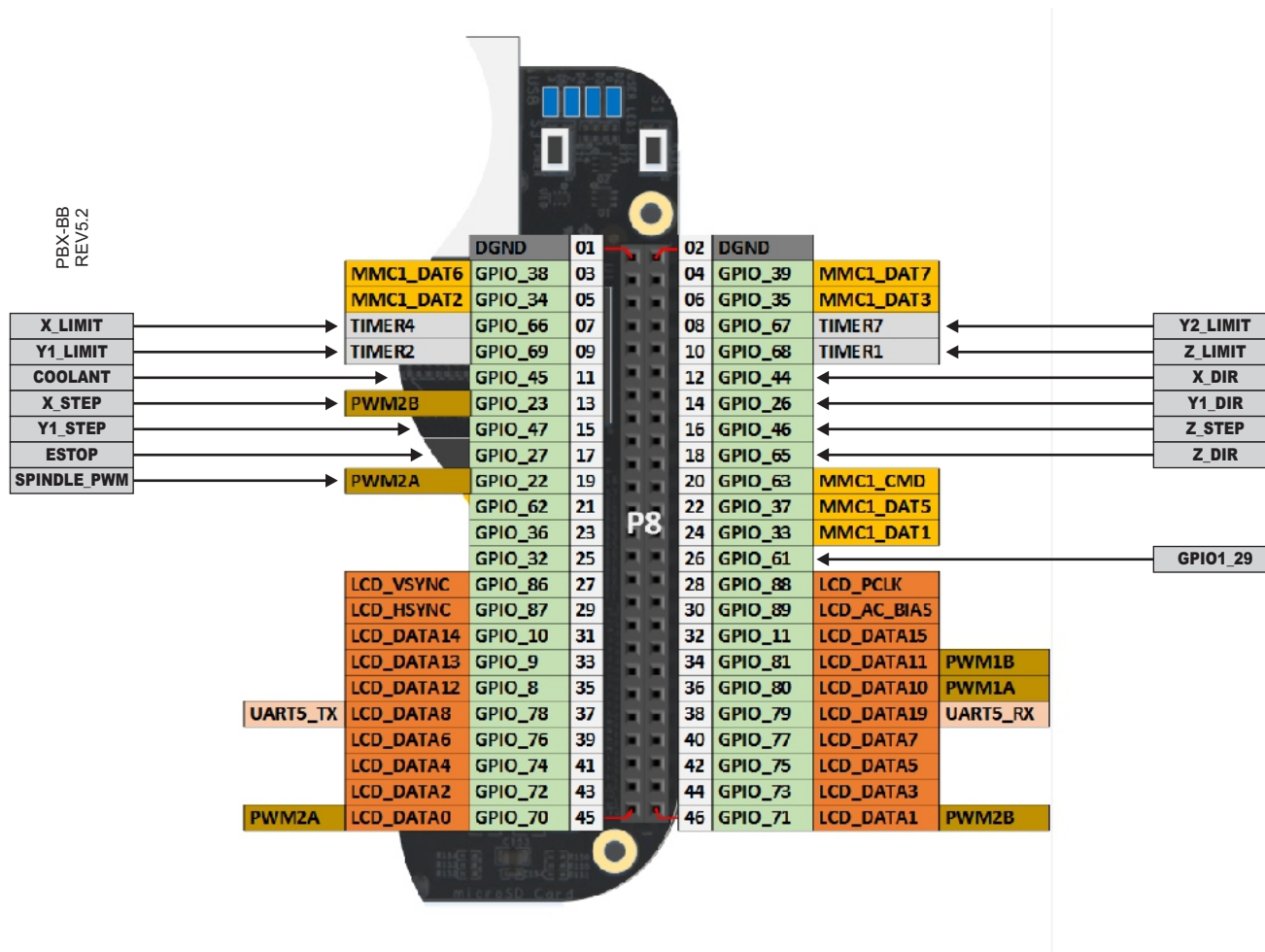

## P9 HEADER

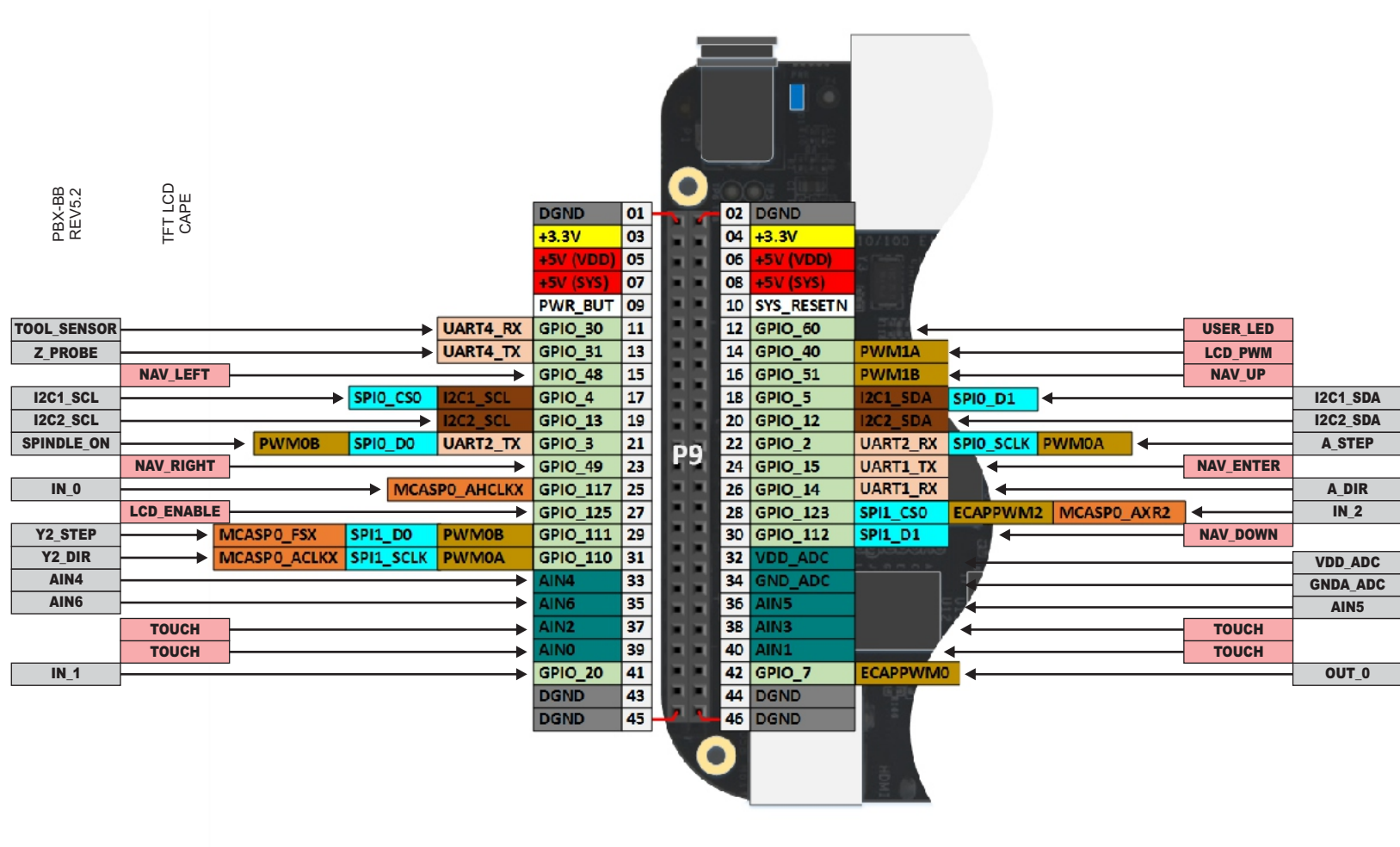

Figure 1: X/Y/Z/A Axis Header Pin Diagram

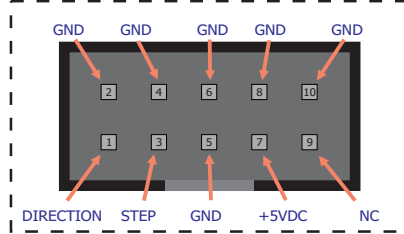

Figure 3: LIMITS Header Pin Diagram

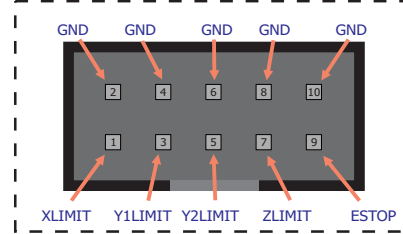

Figure 4: AUX Header Pin Diagram

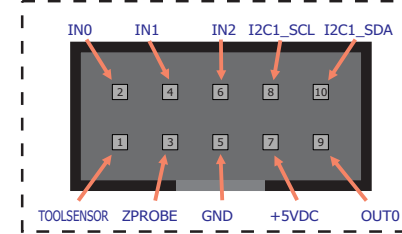

Figure 2: RBX-1 Header Pin Diagram

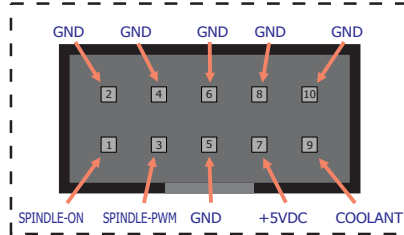
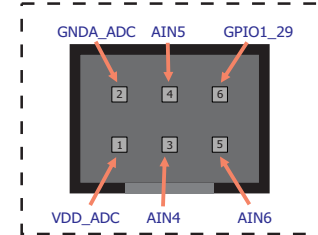

Figure 4: AIN Header Pin Diagram



# PBX-BB Rev5.2

