

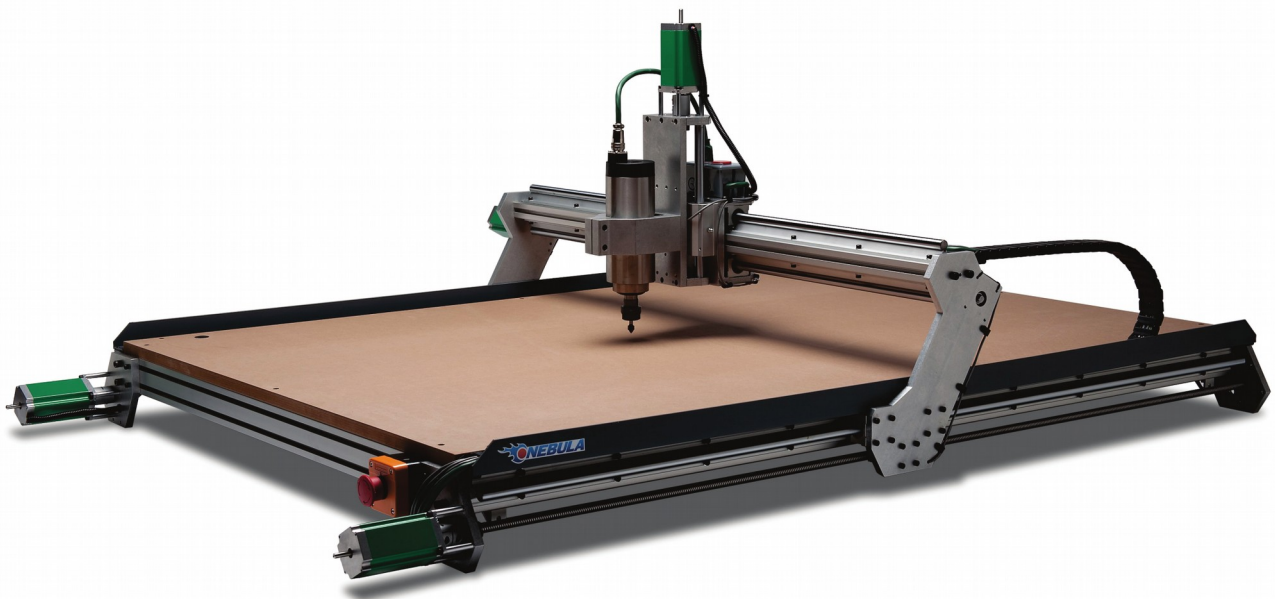

GX SERIES CNC ROUTERS

Quick Start Guide



www.probotix.com
844-472-9262

HOW TO GET HELP

Online Support

<https://www.probotix.com/wiki/>

<https://www.probotix.com/forum/>

support@probotix.com

Telephone Support

844-472-9262

MACHINE FOOTPRINTS

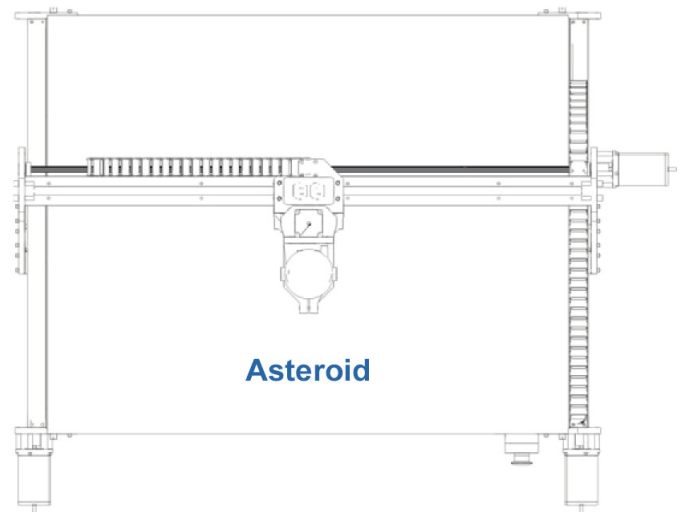
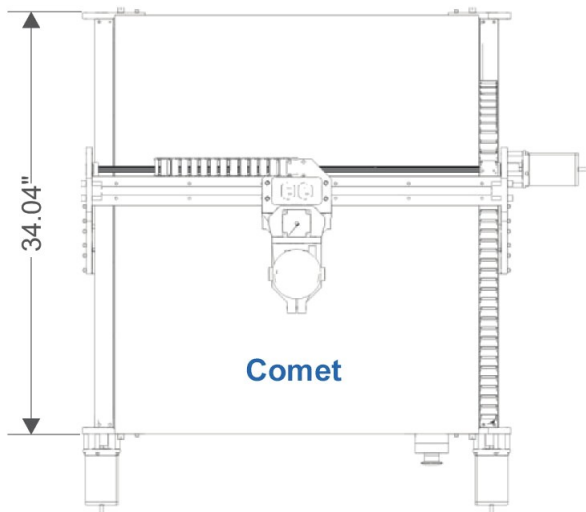
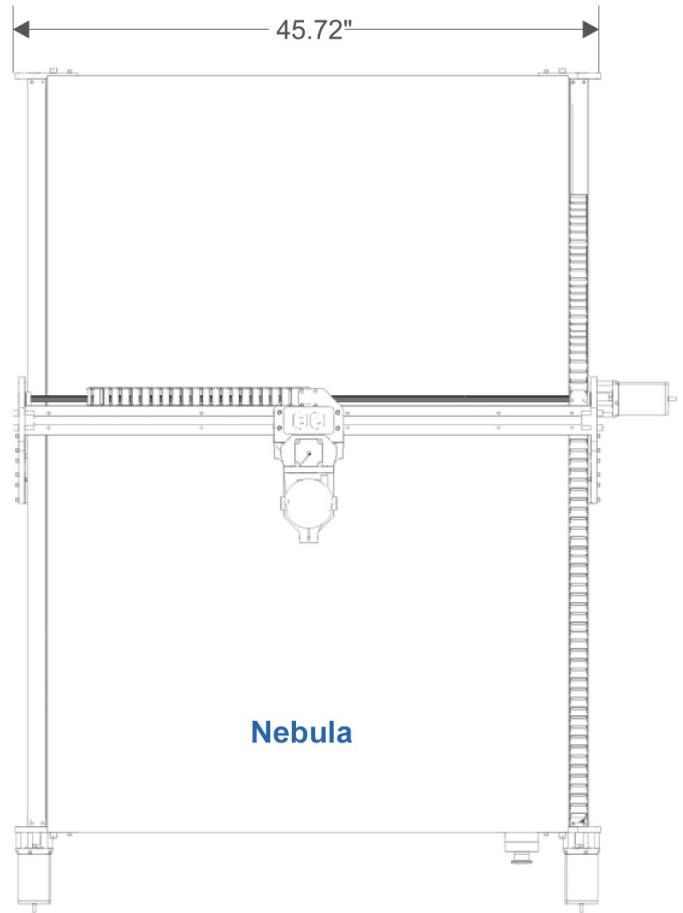
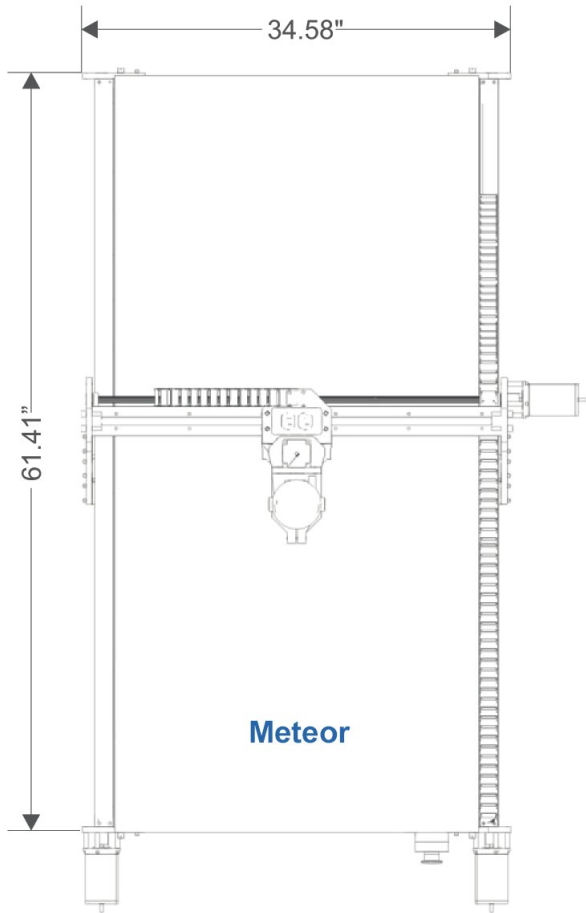

CONNECTION DIAGRAM (ROUTER)

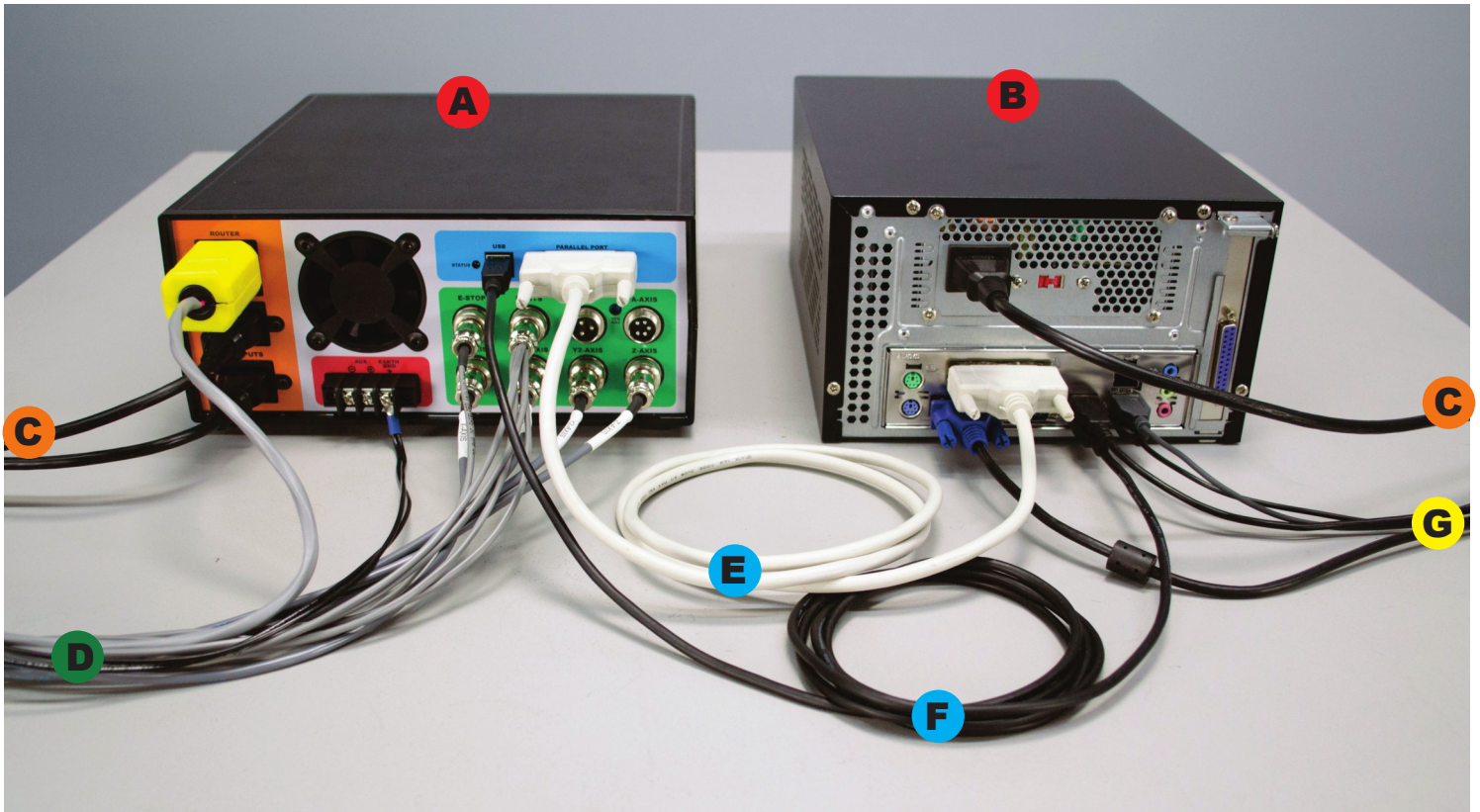

- A** UNITY CONTROLLER
- B** COMPUTER
- C** 110VAC POWER
- D** MACHINE HARNESS
- E** PARALLEL CABLE
- F** USB CABLE
- G** KEYBOARD, MOUSE, MONITOR, JOG PENDANT

CONNECTION DIAGRAM (VFD SPINDLE)

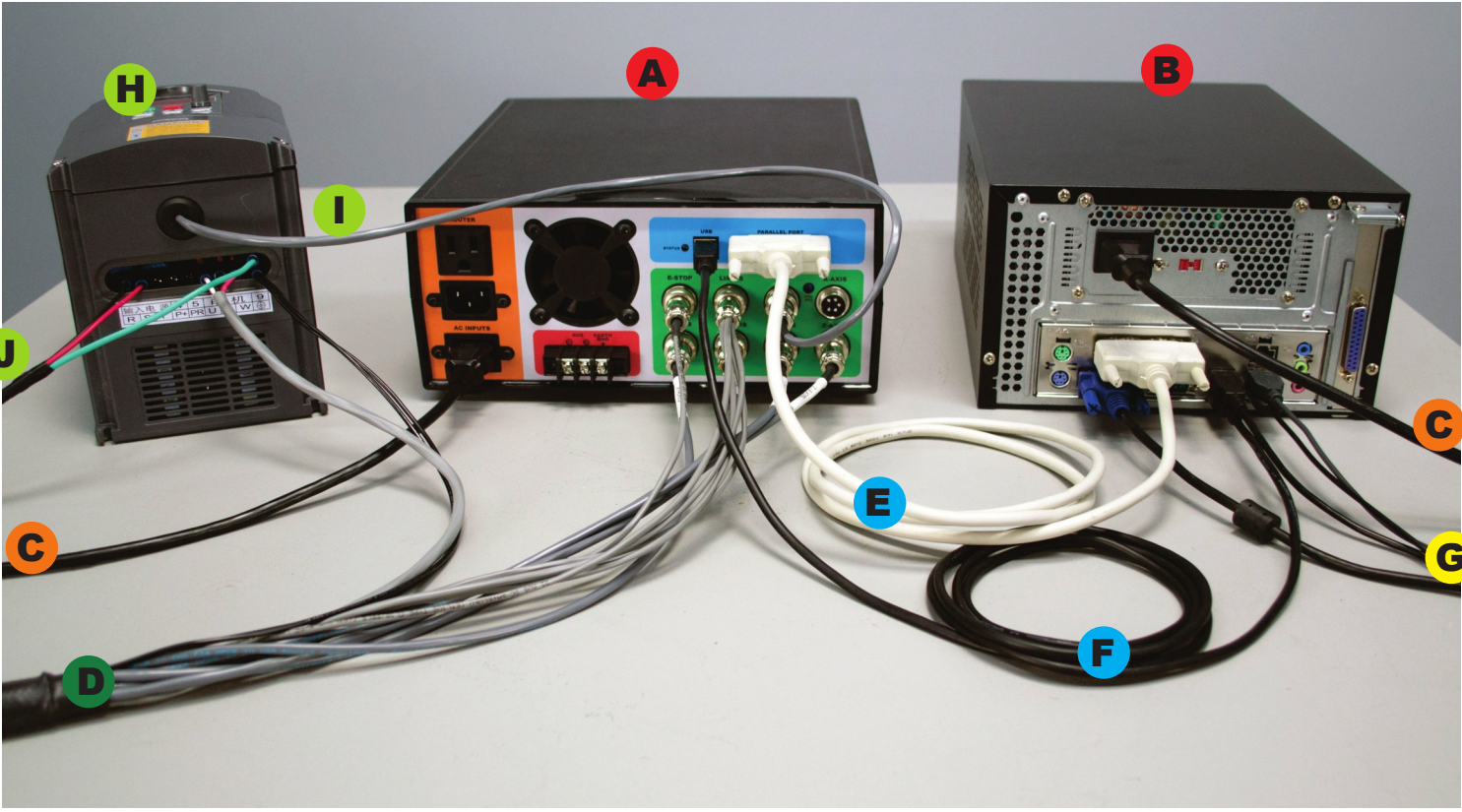

- A** UNITY CONTROLLER
- B** COMPUTER
- C** 110VAC POWER
- D** MACHINE HARNESS
- E** PARALLEL CABLE
- F** USB CABLE
- G** KEYBOARD, MOUSE, MONITOR, JOG PENDANT
- H** VFD
- I** VFD CONTROL CABLE
- J** 220VAC

UNITY CONTROLLER PORTS



A AC INPUT Primary power input for the machine/controller.

B AC INPUT Power input for relay controlled 110VAC outlet, connection C.

C 110VAC OUTLET Control commands dependent on configuration:
 • ROUTER: via M3/M5
 • VFD: via M8/M9

D USB POWER INPUT Provides 5VDC power for the breakout board.

E PARALLEL PORT Connect to the primary (PARAPORT0) DB25 port on the PC

F G H I J MOTOR CONNECTIONS Connect to each motor as labeled from the machine harness.

K VFD Connect to 3-pin VFD cable for speed control of a VFD spindle.

L LIMITS Connect to the 8-pin limit switch connector from the machine harness.

M E-STOP Connect to the 2-pin e-stop connector from the machine harness.

N EARTH GND Connect to the two twisted wires from the machine harness. Additional earth grounding may be necessary when working with certain spindles or types of materials that may cause excess EMI or static electricity.

O 5VDC AUX **Do not use with VFD spindle.** 5VDC signal that can be connected to a PowerSwitch Tail or other 5V@20mA relay circuit controlled via M7/M9.

VFD WIRING DETAIL

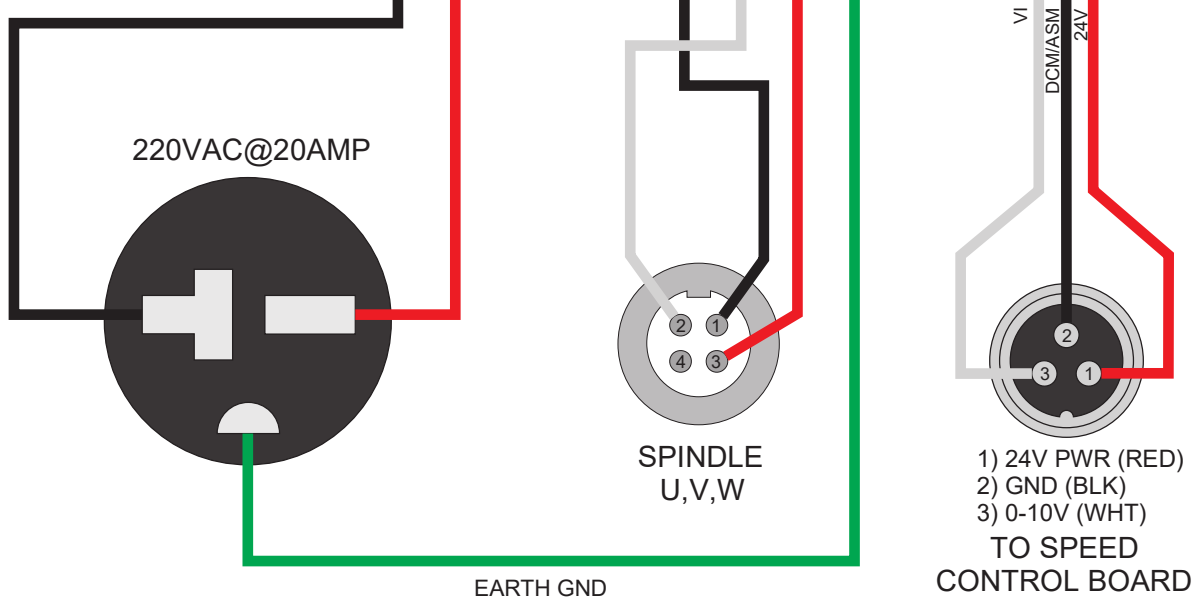
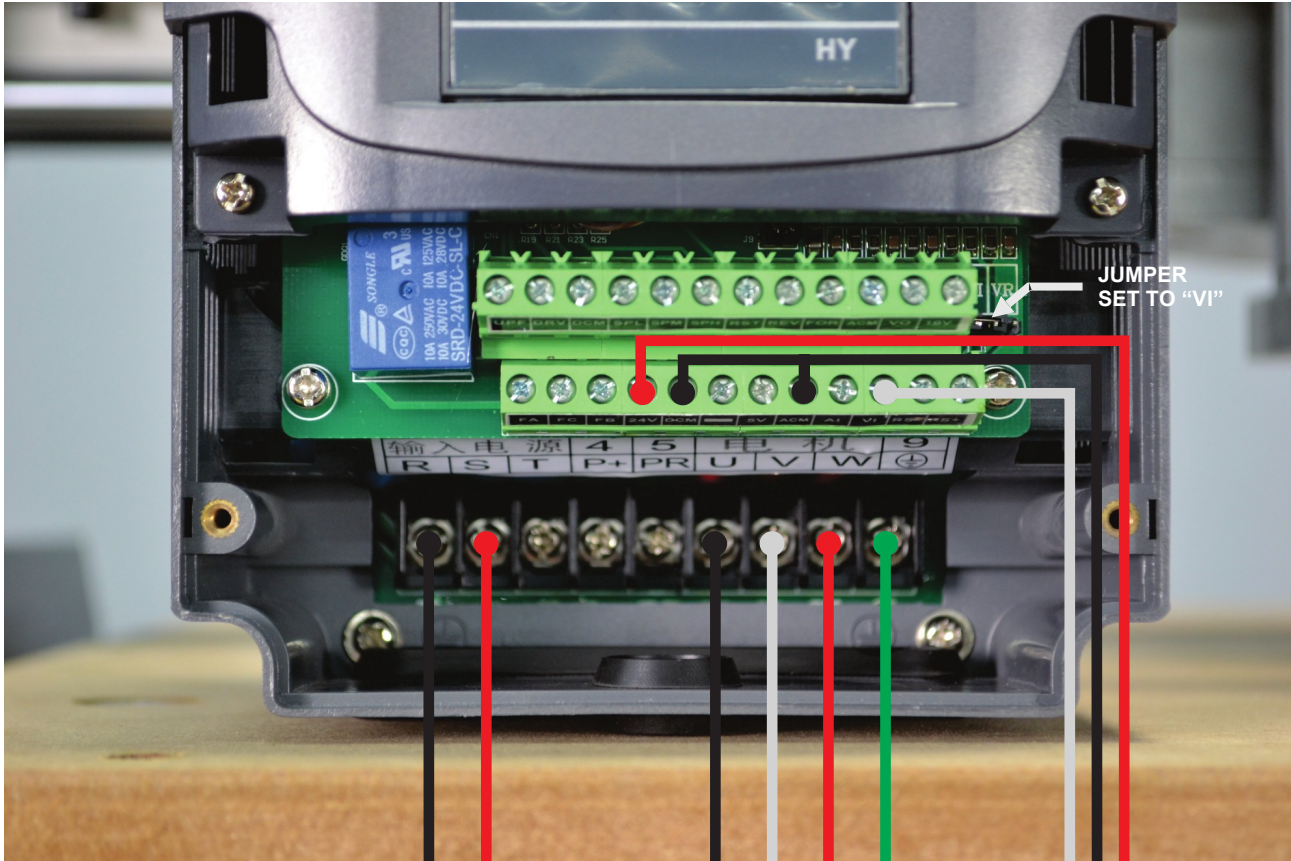

NOTICE: Internal wiring of Chinese spindles is not consistent. If spindle spins in reverse, swap U & V. You MUST verify visually or physically the proper rotation of the spindle to ensure the machine cuts properly!

VFD WIRING DETAIL (SUNFAR E300)

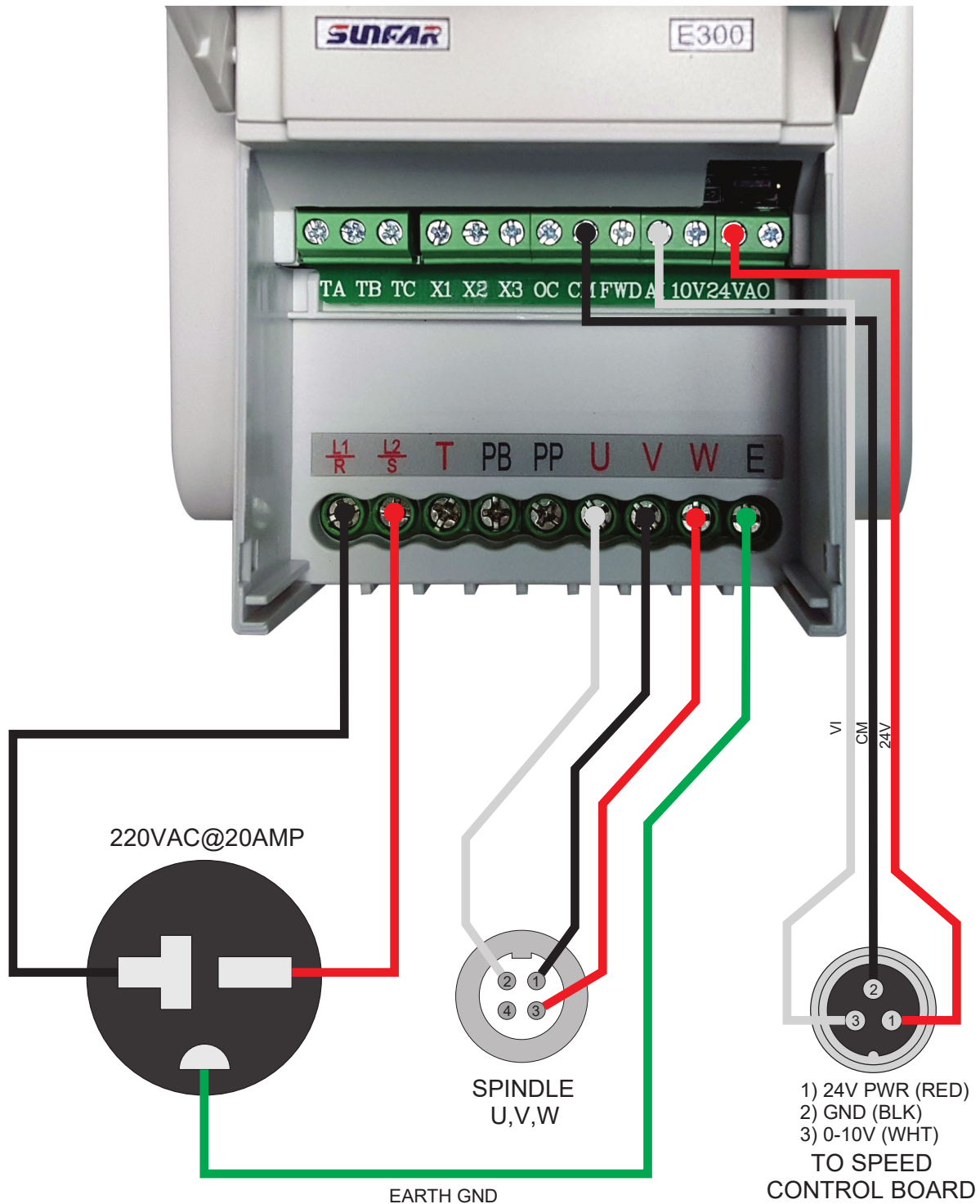

NOTICE: Internal wiring of Chinese spindles is not consistent. If spindle spins in reverse, swap U & V. You MUST verify visually or physically the proper rotation of the spindle to ensure the machine cuts properly!

VFD WIRING DETAIL (SUNFAR E500)

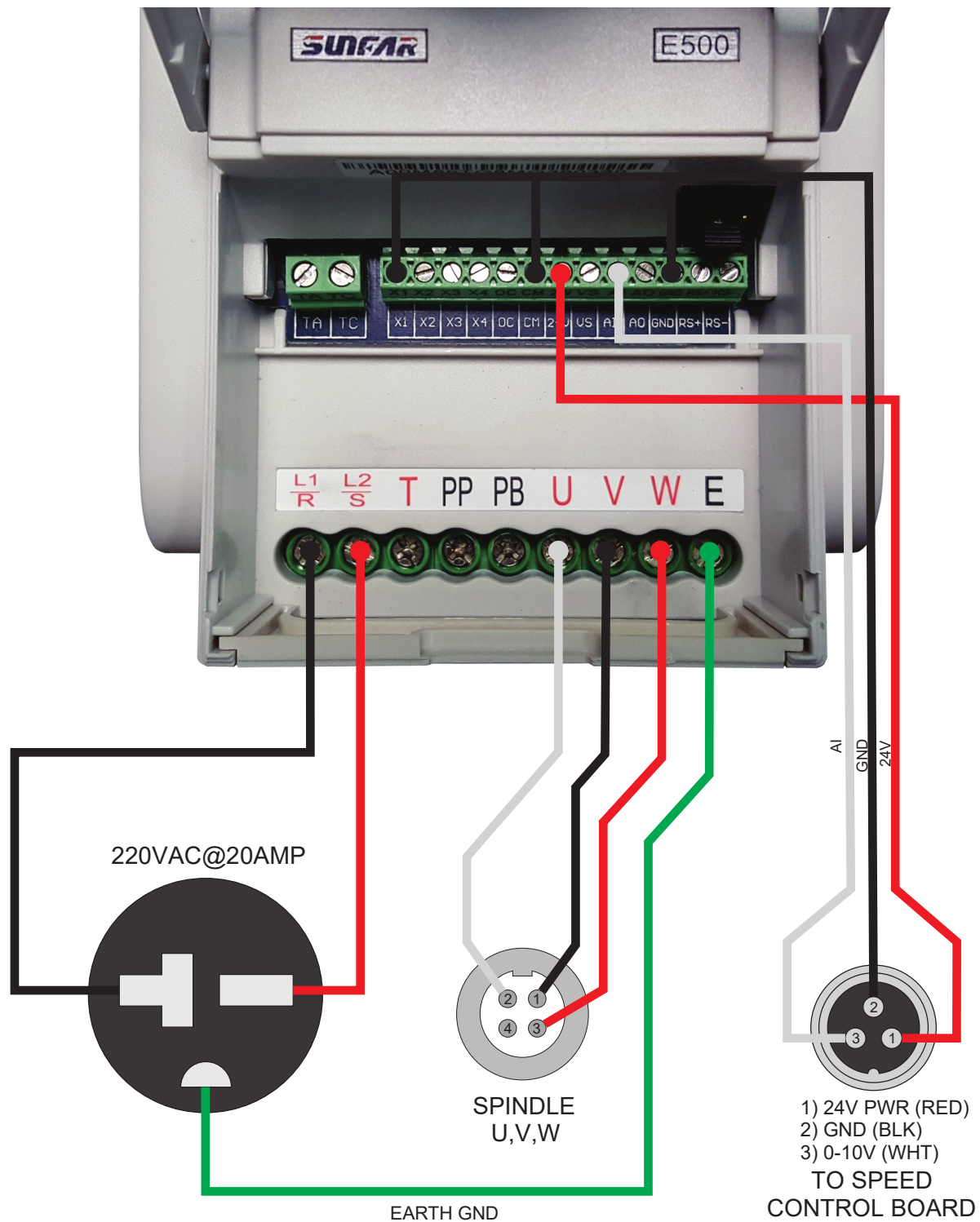

NOTICE: Internal wiring of Chinese spindles is not consistent. If spindle spins in reverse, swap U & V. You MUST verify visually or physically the proper rotation of the spindle to ensure the machine cuts properly!

Z MOTOR



The Z motor has been removed for shipping and must be reinstalled prior to running the machine. Mount the Z motor to the top coupler as pictured using the included hardware .

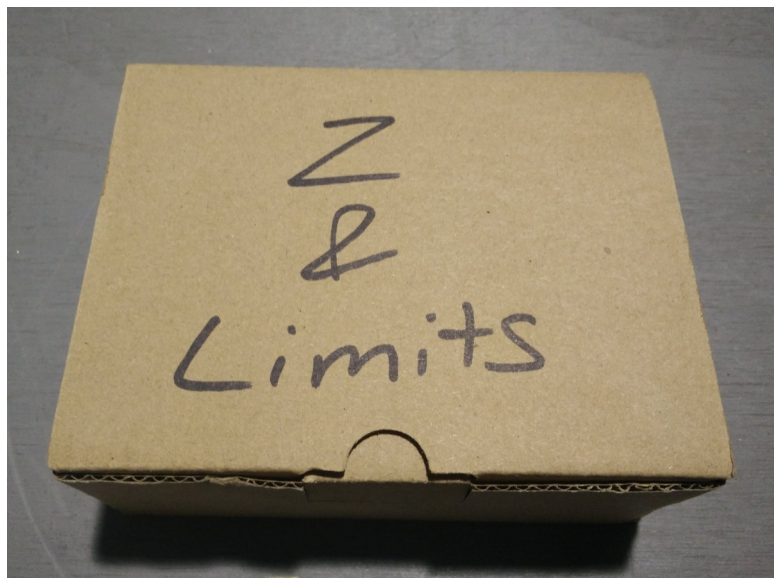

The box contains the limit switches that can be reconnected to each Y axis , and standoffs w/ screws for installing the Z motor back on top of the axis. You will need the following tools:

- M3 hex key/screw driver for motor standoffs
- M2 tool for limit switches



Box includes standoffs and limit switches shown

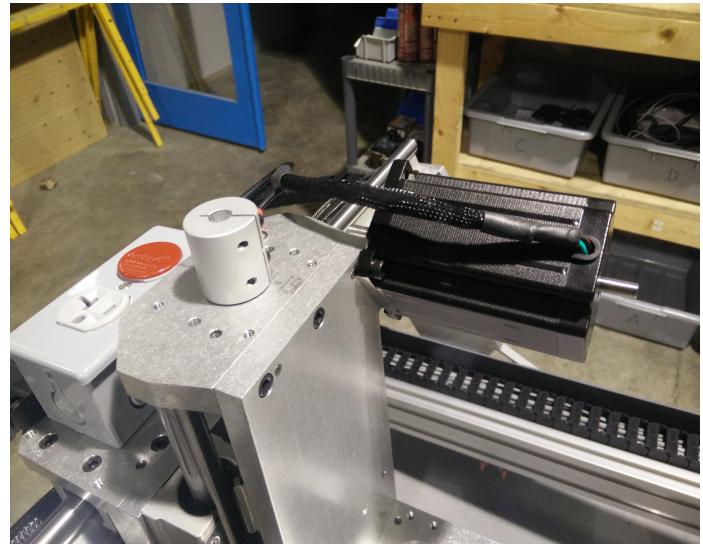

Motor is mounted sideways to fit in crate

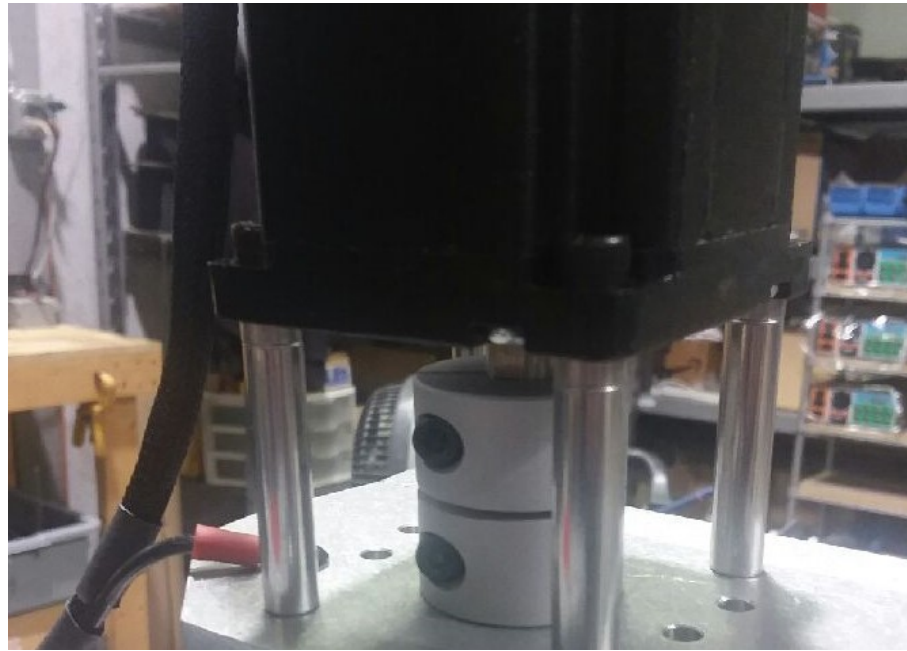

Finished Z Motor should look like above

LIMIT SWITCHES

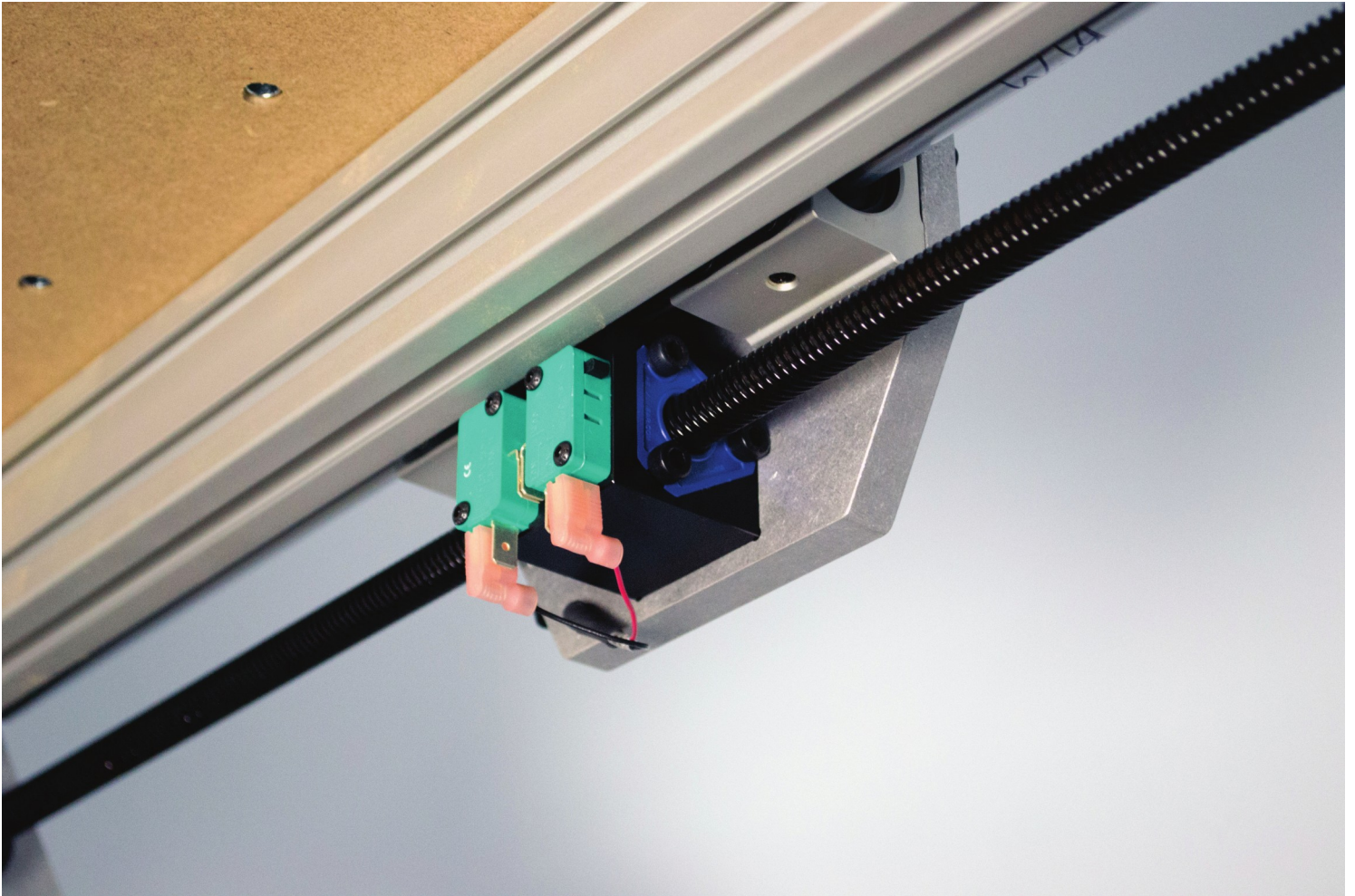



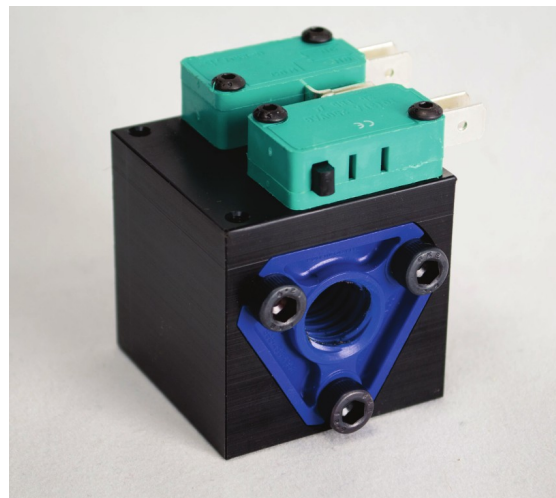





The Y1 and Y2 limit switches have been removed to protect them during transport. Reinstall them to the outermost posts, as seen above, before running the machine

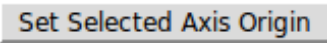

GETTING STARTED

Simple Start Up Procedure:

- Start computer
- Launch LinuxCNC from icon on desktop 
- Turn power on Unity Controller
- Verify red E-Stop indicator follows physical e-stop 
- Click orange Machine Power button 
- Click the Home All button 
- Click the icon to open g-code file  or 
- Load tool into spindle or router
- Mount stock on the table
- Jog machine to place tool on origin of part
- Perform touch-off sequence (all 3 axis) 
- Verify spindle power switch is on
- Hit the Run button 
- Watch in awe

* Additional instructions for the Z Touch-off Puck and the ATLaS Automatic Tool Length Sensor can be found on the wiki:

<https://www.probotix.com/wiki/>

CAM SOFTWARE

You can use any CAM software to generate g-code for LinuxCNC. Most CAM software programs will have appropriate post processors named either LinuxCNC or EMC2. You can use generic g-code post processors as well. We also have post processors on our wiki specifically for our machines. If using the ATLaS Automatic Tool Length Sensor, you need to make sure the post processor you are using is inserting the proper tool change routine.

G54 COORDINATE SYSTEM

CNC machines use a numbered coordinate system. G54 is the default coordinate system. Some post processors carelessly do not insert a coordinate system. The results of not specifying a coordinate system in the g-code is unpredictable and dangerous. Be sure the coordinate system is being inserted into the g-code preamble.

TOUCHING OFF

After you mount your stock to the table and insert the tool you will be cutting with, use the jog controls to move the tool to the origin of the part. This is the same location you told the CAM software you wanted the origin to be. It could be on one of the corners of the part, or top center of the part. Then choose each axis and click [Set Selected Axis Origin](#)

The axis that we are setting the origin for.

The current position of the tool relative to the stock at this moment. May be zero, may be the thickness of the piece of paper you are sliding under the tool.

This needs to match the coordinate system that the CAM software is inserting into the g-code.

G64 PATH OPTIMIZATION

Except for in the case of full 90 degree arcs, CAM software will break any curves in your designs up into a bunch of tiny segments. This will create jittery motion, will create tool marks in the part, shorten your tool life, and can extend the cut times significantly. Fortunately, LinuxCNC has a mode called G64 path optimization.

When G64 is turned on, LinuxCNC will perform a look-ahead and calculates the angle of the next segment(s), only slowing down as little as possible to round the corner(s). It tries to maintain the programmed velocity as close as possible, while not violating the velocity and acceleration capabilities of the machine. If G64 is programmed without a P parameter, LinuxCNC will take its liberty and round over those corners as much as it needs, the faster the feedrate, the greater the deviation from the programmed location. While cutting a square at only 10IPM will be a near perfect square, cutting that same square at 100IPM will result in 3 extremely rounded corners. In LinuxCNC, G64 is turned on by default (look for it under active g-codes under the MDI tab), but it does not have this P parameter (tolerance) by default.

The simple solution is to type G64 P0.010 into the MDI command box and hit go. This will tell LinuxCNC to yes, turn on path optimization, but do not deviate more than 0.010" from where I told you to go. The tolerance you use will depend upon the types of parts you are making. You will want to set it to 0.010 or more for decorative type things, especially while 3D carving. For more precise parts, You will use 0.001. G61 cancels G64 and will cause the machine to come to a complete stop at the end of every segment.

One more thing... You can put that G64 line in the preamble of your post processor so that it inserts it into every g-code file. It is modal, so it stays the same unless explicitly changed with another G64 Pxxx, or canceled with a G61. It also resets when the software is restarted. The most efficient way to manage this is to create separate post processor for each tolerance level you want to use.

Do not confuse G64 Path Optimization with the G54 Coordinate System

More information about this and other topics can be found on the wiki:

<https://www.probotix.com/wiki/>

MAINTENANCE

Daily Use:

Put a couple of drops of 3-in-1 oil on each of the six linear rails before homing the machine each day. This will allow a tiny amount of oil to be sucked up into the bearing housings before cutting any parts.

Use any linear motion grease on the leadscrews. A light coating is enough, as Delrin is self-lubricating. You can use WD-40 and an air nozzle to remove debris from the screw. Be sure to dry the screw of the WD-40 before re-applying grease as WD-40 is a solvent and will dissolve the grease.

The Grease Zerks on the z-axis bearings are not used.

All of the other bearings are sealed. The most important thing is to keep any dust cleaned off of the machine, especially if you are cutting abrasive materials such as MDF, fiberglass, or carbon fiber.

High Humidity Environments & Storage:

If you use your machine in a high humidity environment, ie in a shed or other non-air-conditioned environment, or if you plan to store it without use, rust can form on the linear rails, leadscrews, and the black-oxide machine fasteners. Coat these surfaces with grease or WD-40 often. Again, be sure to dry the screws and rails of the WD-40 before re-applying grease and oil before use. The black-oxide machine fasteners will not need to be wiped dry.

Bearing Replacements:

Depending on the amount of use and the loads on the machine for your application, the linear bearings and leadscrew ball bearings will need to be replaced eventually. You will notice excess slop, marks on the rails, or jerky motion on the affected axis. Replace them annually for worry free operation.

Anti-backlash Nuts:

The Delrin anti-backlash nuts are designed to wear and may need to be replaced periodically, depending upon the amount of use and abuse your machine receives. When they fail, you will notice backlash on the affected axis. You can check them by pulling and pushing on each axis and observing slop between the leadscrew and the drive nuts. To replace them, you will need to remove the leadscrews. Replace them annually for worry free operation.

LINUXCNC KEYBOARD SHORTCUTS

ESCAPE	E-STOP
F1	TOGGLE E-STOP
F2	TOGGLE MACHINE POWER
F3	MANUAL MODE
F4	AUTO MODE
F5	MDI MODE
F6	RESET INTERPRETER
F7	TOGGLE MIST
F8	TOGGLE FLOOD
F9	TOGGLE SPINDLE FORWARD
F10	TOGGLE SPINDLE REVERSE
F11	DECREASE SPINDLE SPEED
F12	INCREASE SPINDLE SPEED
X	SELECT X-AXIS
Y	SELECT Y-AXIS
Z	SELECT Z-AXIS
LEFT/RIGHT ARROW	JOG X-AXIS
UP/DOWN ARROW	JOG Y-AXIS
PAGE UP/DOWN	JOG Z-AXIS
HOME	HOME SELECTED AXIS
END	TOUCH-OFF SELECTED AXIS
</>	DECREASE/INCREASE JOG SPEED
C	SELECT CONTINUOUS JOGGING
I	SELECT INCREMENTAL JOGGING AND TOGGLE BETWEEN INCREMENTS
1-9,0	FEED OVERRIDE 10%-90%, 0 IS 100%
@	TOGGLE COMMANDED/ACTUAL POSITION DISPLAY
#	TOGGLE ABSOLUTE/RELATIVE POSITION DISPLAY
O	OPEN A PROGRAM
R	RUN THE OPENED PROGRAM
P	PAUSE PROGRAM
S	RESUME PAUSED PROGRAM
A	STEP ONE LINE IN PAUSED PROGRAM
B	TAKE SPINDLE BREAK OFF
ALT-B	PUT SPINDLE BRAKE ON
ALT-S	START LOGGING
ALT-P	PAUSE LOGGING
ALT-F	SAVE LOG FILE
CTRL-P	PRINT LOG FILE (ONLY WITH XGRAPH)

G-CODE QUICK REFERENCE

Motion		
G0		Rapid motion
G1		Coordinated motion ("Straight feed")
G2, G3	I J K or R	Coordinated helical motion ("Arc feed") CW or CCW
G38.2		Straight Probe
G80		Cancel motion mode
G81	R L P	Drilling Cycle
G82...G89	R L P Q	Other canned cycles
G33	K	Spindle-synchronized motion
G33.1	K	Rigid Tapping
G76	P Z I J R K Q H L E	Multipass lathe threading cycle
Plane Selection (affects G2, G3, G81...G89, G40...G42)		
G17		Select XY plane
G18		Select XZ plane
G19		Select YZ plane
Distance Mode		
G90		Absolute distance mode
G91		Incremental distance mode
Feed Rate Mode		
G93		Inverse time feed rate
G94		Units per minute feed rate
G95		Units per revolution
Units		
G20		Inches
G21		Millimeters
Cutter Radius Compensation		
G41, G42	D	Start cutter radius compensation left or right
G41.1, G42.1	D L	Start cutter radius compensation left or right, transient tool
G40		Cancel cutter radius compensation
Tool Length Offset		
G43	H	Use tool length offset from tool table
G43.1	I K	Use specified tool length offset for transient tool
G49		Cancel tool length offset
Return Mode in Canned Cycles		
G98		Retract to R position
G99		Retract to prior position
Path Control Mode		
G61		Exact Path mode
G61.1		Exact Stop mode
G64	P	Continuous mode with optional path tolerance
Stopping		
M0		Pause Program
M2		End Program
M1, M30, M60		Other stop codes
Spindle Control		
M3, M4	S	Turn spindle clockwise or counterclockwise
M5		Stop spindle
G96	D S	Constant surface speed mode (foot/minute or meter/minute) with top speed
G97		RPM mode
Coolant		
M7		Turn mist on
M8		Turn flood on
M9		Turn all coolant off
Other Modal Codes		
F		Set Feed Rate
S		Set Spindle Speed
T		Select Tool
M50...M53	P0 (off) or P1 (on)	Feed Override, Spindle Override, Adaptive Feed, Feed Hold
G54...G59, G59.1...G59.3		Select coordinate system
Flow-control Codes		
O ...		sub/endsub, while/endwhile, if/else/endif, do/while, call, break/continue/return
Non-modal Codes		
M6	T	Change tool
G4	P	Dwell (seconds)
G10 L2	P X Y Z A B C	Coordinate system origin setting
G28		Return to home
G30		Return to secondary home
G53		Motion in machine coordinate system
G92	X Y Z A B C	Offset coordinate systems and set parameters
G92.1		Cancel offset coordinate systems and set parameters to zero
G92.2		Cancel offset coordinate systems but do not reset parameters
G92.3		Apply parameters to offset coordinate systems
M101...M199	P Q	User-defined M-codes
(...)		A comment "..." to the user
(MSG,...)		Display the message "..." to the user (e.g., in a popup)
(DEBUG,...#123...#<foo>)		Display the message (with variables substituted) like MSG
(PRINT,...#123...#<foo>)		Display the message (with variables substituted) to stderr

Table 1. Coordinate System

P Value	Coordinate System	G code
0	Active	n/a
1	1	G54
2	2	G55
3	3	G56
4	4	G57
5	5	G58
6	6	G59
7	7	G59.1
8	8	G59.2
9	9	G59.3

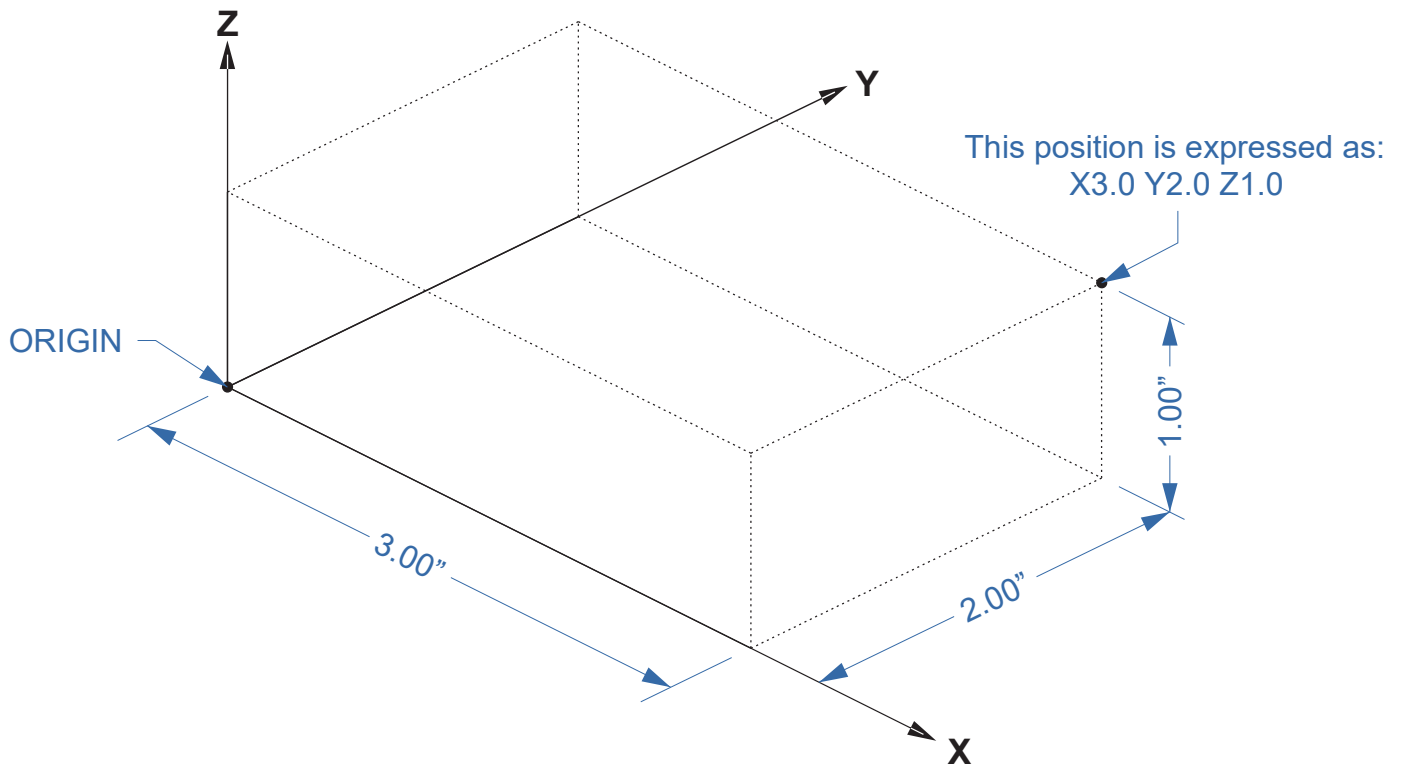

31-5000	G code user parameters. These parameters are global in the G code file, and available for general use. Volatile.
5061-5069	Coordinates of a G38 probe result (X, Y, Z, A, B, C, U, V & W). Coordinates are in the coordinate system in which the G38 took place. Volatile.
5070	G38 probe result: 1 if success, 0 if probe failed to close. Used with G38.3 and G38.5. Volatile.
5161-5169	"G28" Home for X, Y, Z, A, B, C, U, V & W. Persistent.
5181-5189	"G30" Home for X, Y, Z, A, B, C, U, V & W. Persistent.
5211-5219	"G92" offset for X, Y, Z, A, B, C, U, V & W. Persistent.
5210	1 if "G92" offset is currently applied, 0 otherwise. Persistent.
5211-5219	G92 offset (X Y Z A B C U V W).
5220	Coordinate System number 1-9 for G54-G59.3. Persistent.
5221-5230	Coordinate System 1, G54 for X, Y, Z, A, B, C, U, V, W & R. R denotes the XY rotation angle around the Z axis. Persistent.
5241-5250	Coordinate System 2, G55 for X, Y, Z, A, B, C, U, V, W & R. Persistent.
5261-5270	Coordinate System 3, G56 for X, Y, Z, A, B, C, U, V, W & R. Persistent.
5281-5290	Coordinate System 4, G57 for X, Y, Z, A, B, C, U, V, W & R. Persistent.
5301-5310	Coordinate System 5, G58 for X, Y, Z, A, B, C, U, V, W & R. Persistent.
5321-5330	Coordinate System 6, G59 for X, Y, Z, A, B, C, U, V, W & R. Persistent.
5341-5350	Coordinate System 7, G59.1 for X, Y, Z, A, B, C, U, V, W & R. Persistent.
5361-5370	Coordinate System 8, G59.2 for X, Y, Z, A, B, C, U, V, W & R. Persistent.
5381-5390	Coordinate System 9, G59.3 for X, Y, Z, A, B, C, U, V, W & R. Persistent.
5399	Result of M66. Check or wait for input. Volatile.
5400	Tool Number. Volatile.
5401-5409	Tool Offsets for X, Y, Z, A, B, C, U, V & W. Volatile.
5410	Tool Diameter. Volatile.
5411	Tool Front Angle. Volatile.
5412	Tool Back Angle. Volatile.
5413	Tool Orientation. Volatile.
5420-5428	Current relative position in the active coordinate system including all offsets and in the current program units for X, Y, Z, A, B, C, U, V & W, volatile.
5599	Flag for controlling the output of (DEBUG,) statements. 1=output, 0=no output; default=1. Volatile.
5600	Toolchanger fault indicator. Used with the iocontrol-v2 component. 1: toolchanger faulted, 0: normal. Volatile.
5601	Toolchanger fault code. Used with the iocontrol-v2 component. Reflects the value of the toolchanger-reason HAL pin if a fault occurred. Volatile.

BUILDING A TABLE

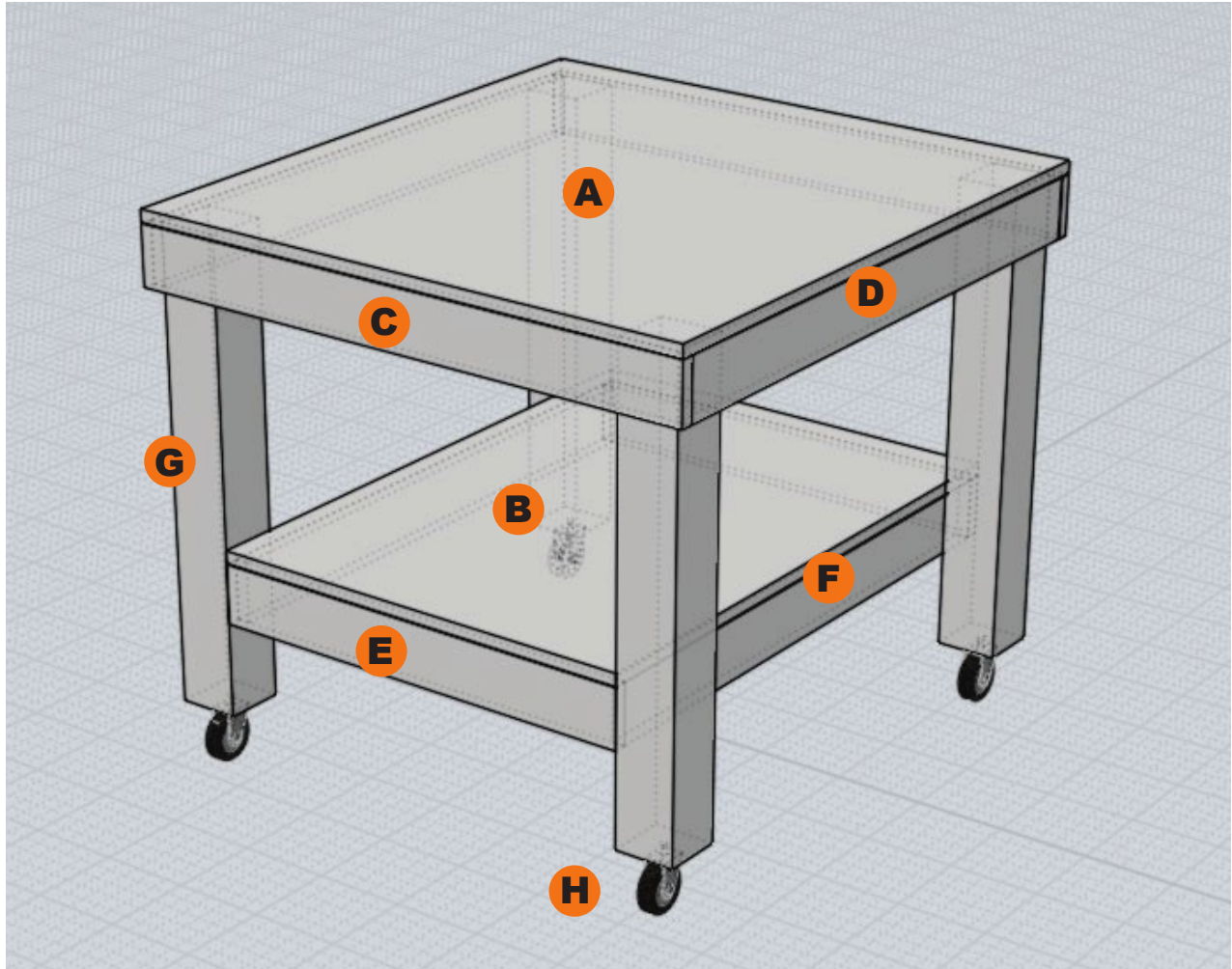

		COMET	ASTEROID	METEOR	NEBULA
A	3/4" MDF or Plywood	34" x 36"	46" x 36"	34" x 64.5"	46" x 64.5"
B	3/4" MDF or Plywood	24.5" x 34.5"	37.5" x 34.5"	25.5" x 63"	37.5" x 63"
C	2pcs 1x4 Pine	34"	46"	34"	46"
D	2pcs 1x4 Pine	34.5"	34.5"	63"	63"
E	2pcs 1x4 Pine	25.5"	37.5"	25.5"	37.5"
F	2pcs 1x4 Pine	33"	33"	61.5"	61.5"
G	4pcs 4x4 Pine	27.25"	27.25"	27.25"	27.25"
H	4pcs 3.5" Tall Locking Castors				

ALUMINUM STAND ASSEMBLY

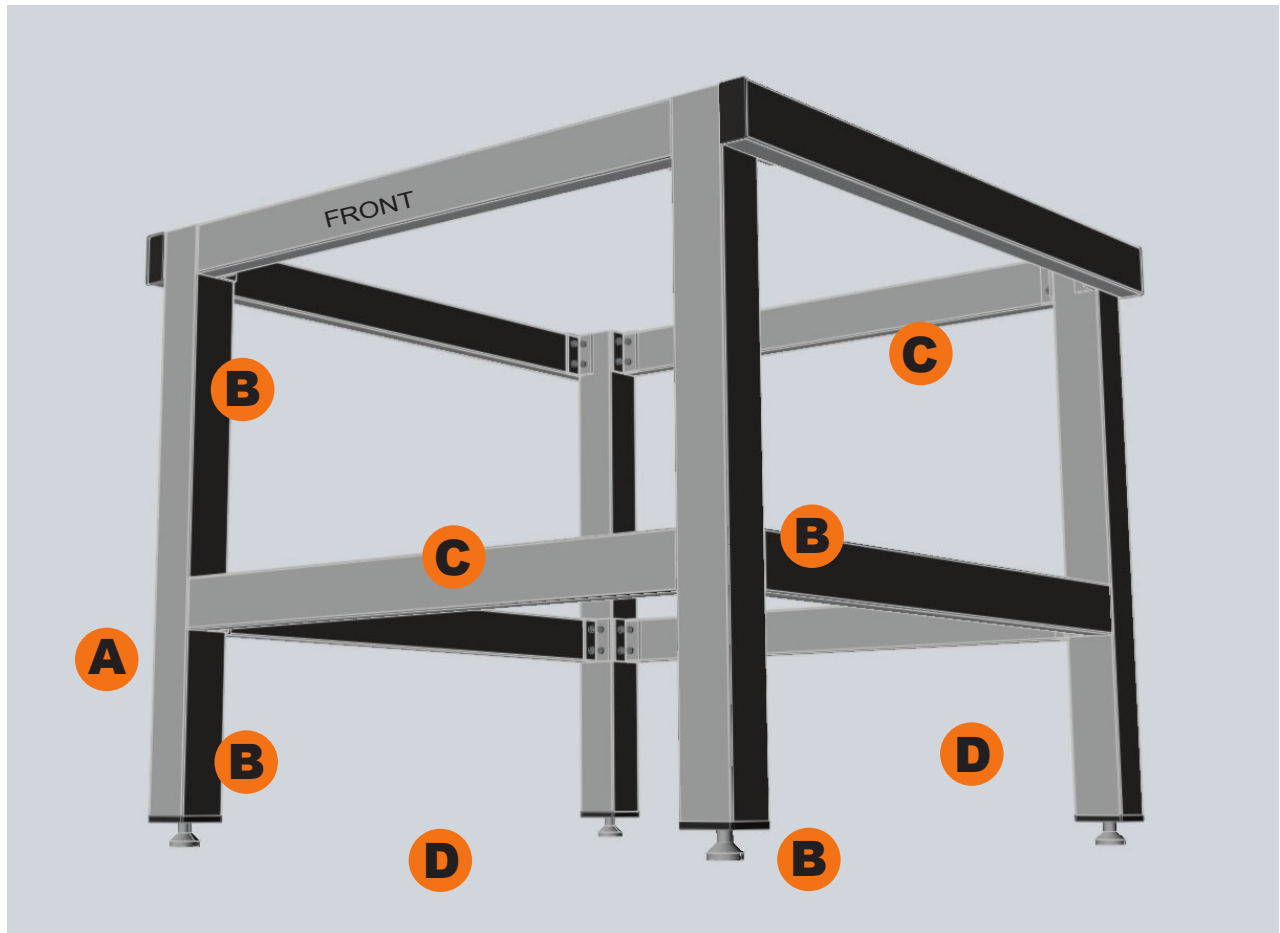

Extrusion Lengths (mm)

		COMET	ASTEROID	METEOR	NEBULA
A	4x Legs (6060)	692	692	692	692
B	Front/Back (3060)	704	987	704	987
C	Top Sides (3060)	832	832	1528	1528
D	Bottom Sides (3060)	718	718	1414	1414

All rails are mounted inside the legs flush to the outside, except for the C rails, which mount to the outside. The B rails are front/back of the machine. The upper rails should be flush with the top while the lower rails can be adjusted up and down as needed.

ALUMINUM STAND MULTI-MOUNTS

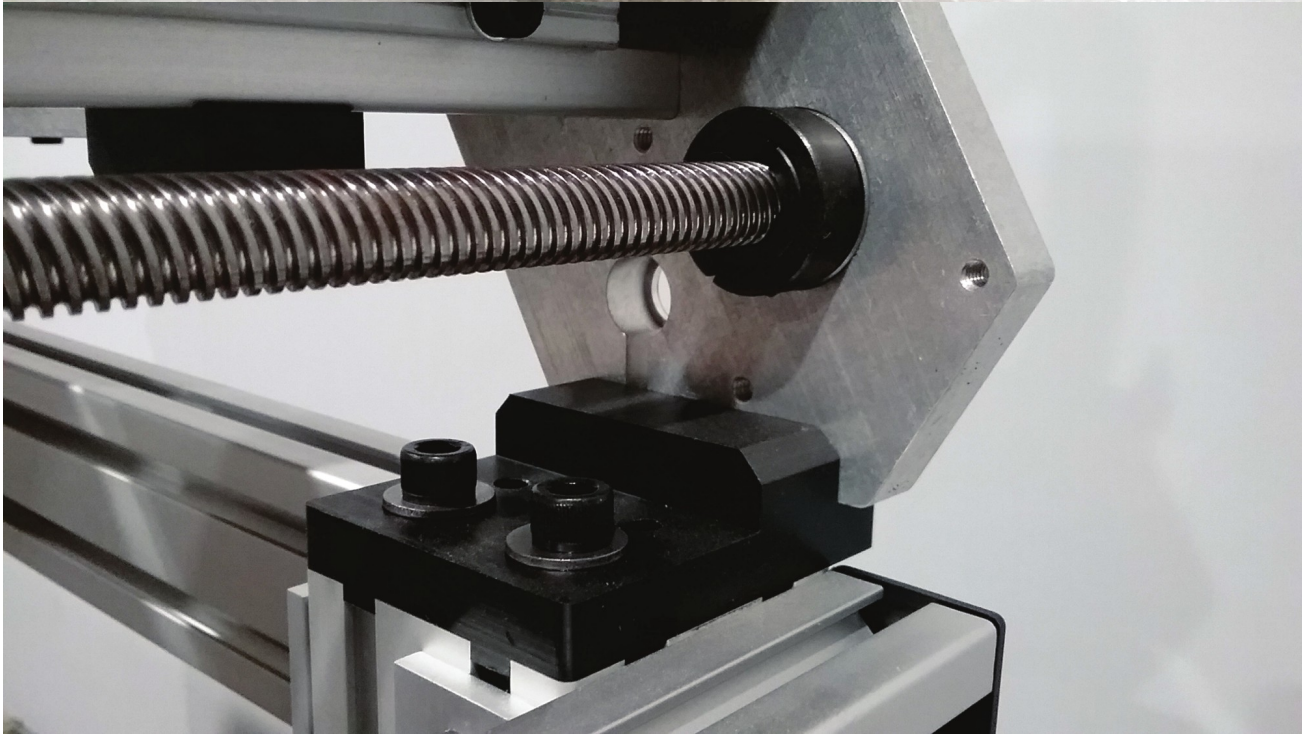

KVM ARM

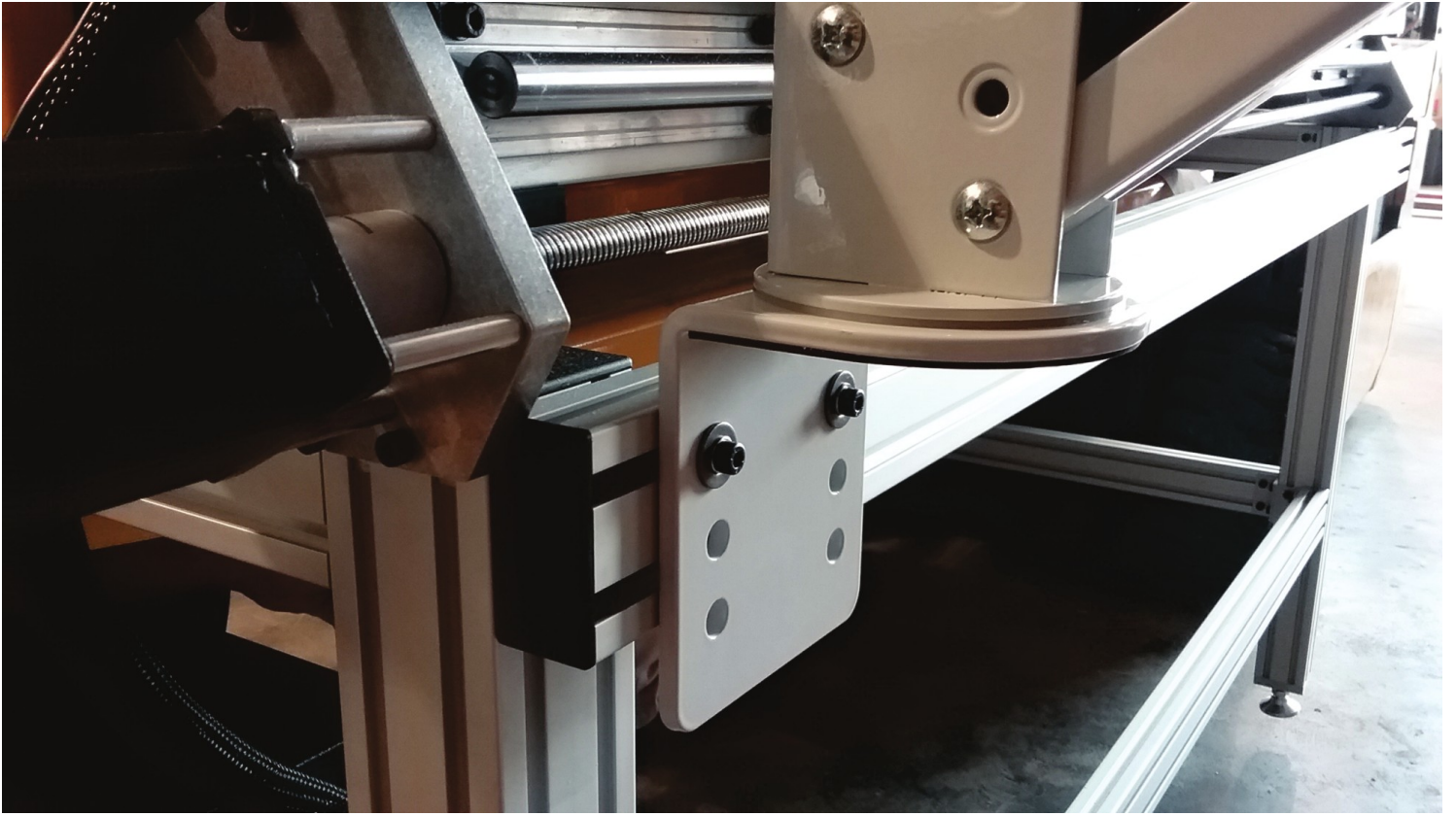

If you also have the KVM arm, you can mount it to the frame as seen above.